







Hanging Mounts

| | | | | | | |
|--------------------|---|---|---|--|---|---|
| |  |  |  |  |  |  |
| | SBP-300HM1 | SBP-300HM5 SBP-300HMW5 | SBP-300HM6 | SBP-300HM7 SBP-300HMW7 | SBP-300HM8 | SBP-301HM2 SBP-301HMW2 |
| Color | Ivory | Ivory / White | Ivory | Ivory / White | Ivory | Ivory / White |
| Material | Aluminum | Aluminum | Aluminum | Aluminum | Aluminum | Aluminum |
| Product Dimensions | Ø179.0 x 55.0mm (Ø7.05" x 2.17") | Ø154.8 x 47.0mm (Ø6.09" x 1.85") | Ø168.0 x 63.0mm (Ø6.61" x 2.48") | Ø120.0 x 51.5mm (Ø4.72" x 2.03") | Ø138.9 x 50.0 (Ø5.47" x 1.97") | Ø144.0 x 51.0mm (Ø5.67" x 2.01") |
| Pipe Thread | 1-1/2" PF | 1-1/2" PF | 1-1/2" PF | 1-1/2" PF | 1-1/2" PF | 1.5" NPT |
| Weight | 470g(1.04lb) | 200g(0.44 lb) | 307g(0.68 lb) | 145g(0.32 lb) | 178g(0.39 lb) | 197g(0.43 lb) |

Dimensions

Unit : mm (inch)

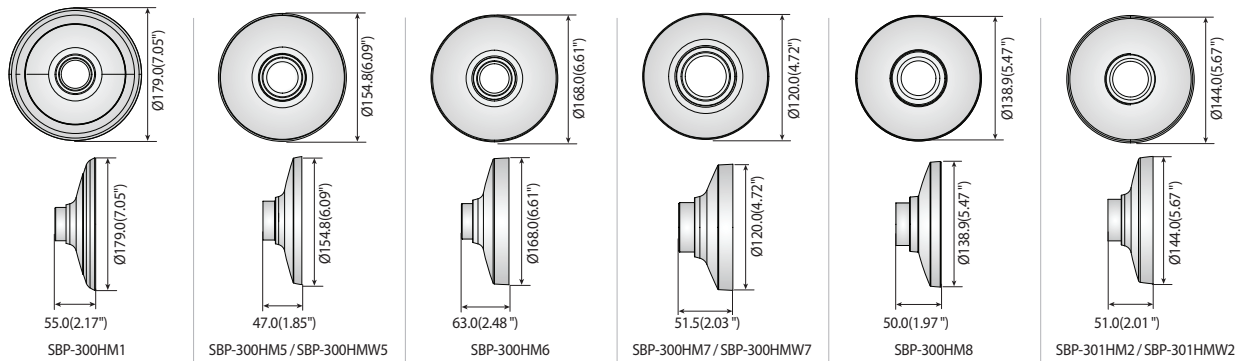

| | | | | | |
|--------------------|---|---|--|---|---|
| |  |  |  |  |  |
| | SBP-301HM3 | SBP-301HM4 | SBP-301HM5 | SBP-122HM SBP-122HMW | SBP-201HM SBP-201HMW |
| Color | Ivory | Ivory | Ivory | Ivory / White | Ivory / White |
| Material | Aluminum | Aluminum | Aluminum | Aluminum | Aluminum |
| Product Dimensions | Ø155.1 x 55.0mm (Ø6.11" x 2.17") | Ø137.0 x 47.0mm (Ø5.39" x 1.85") | Ø144.0 x 51.0mm (Ø5.67" x 2.01") | Ø128.2 x 47.0mm (Ø5.05" x 1.85") | Ø205.9 x 75.0mm (Ø8.11" x 2.95") |
| Pipe Thread | 1.5" NPT | 1-1/2" PF | 1.5" NPT | 1-1/2" PF | 1-1/2" PF |
| Weight | 270g(0.60 lb) | 165g(0.36 lb) | 197g(0.43 lb) | 159g(0.35 lb) | 496g(1.09 lb) |

Dimensions

Unit : mm (inch)

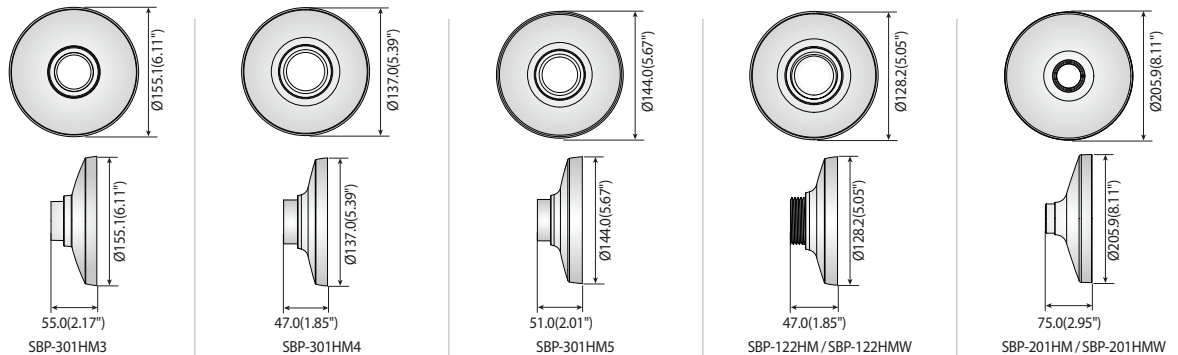

* You can find applicable models with accessory selector www.hanwha-security.com/en/products/accessory-selector/

* The latest product information / specification can be found at hanwha-security.com

* Design and specifications are subject to change without notice.

* Wisenet is the proprietary brand of Hanwha Techwin formerly known as Samsung Techwin.

Hanging Mounts

| |  |  |  |  |
|--------------------|---|---|--|---|
| | SBP-317HM | SBP-329HM | SBP-168HM | SBP-276HM |
| Materials | Aluminum | Aluminum | Aluminum | Aluminum |
| Dimensions (WxHxD) | Ø322 x 90mm (Ø12.68" x 3.54") | Ø336 x 101.5mm (Ø13.23" x 3.99") | Ø191.3 x 124.1mm (Ø7.53" x 4.89") | Ø276.0 x 90.0mm (Ø10.86" x 3.54") |
| Weight | 980g (2.15 lb) | 1,182g (2.60 lb) | 770g (1.69 lb) | 830g (1.83 lb) |
| Color | Ivory | Ivory | Ivory | Ivory |

* You can find applicable models with accessory selector www.hanwha-security.com/en/products/accessory-selector/
 * The latest product information / specification can be found at hanwha-security.com
 * Design and specifications are subject to change without notice.
 * Wisenet is the proprietary brand of Hanwha Techwin formerly known as Samsung Techwin.

Dimensions

Unit : mm (inch)

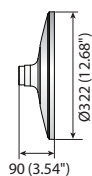
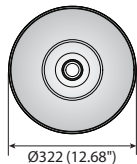

SBP-317HM

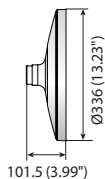
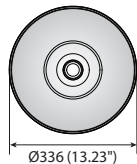

SBP-329HM

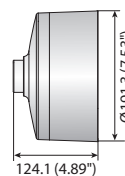

SBP-168HM

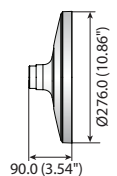
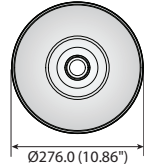

SBP-276HM