

Coverage

Top view

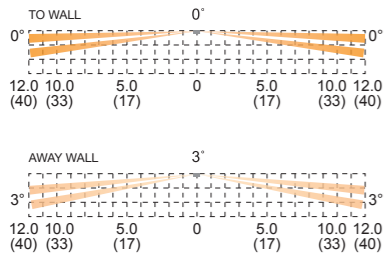

Side view

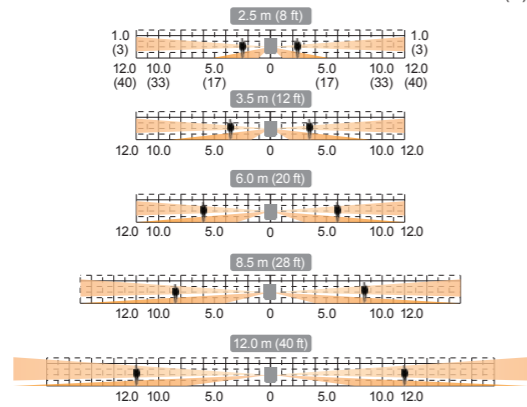

Unit: m (ft.)

Dimensions

BXS-ST / BXS-AM

Unit: mm (inch)

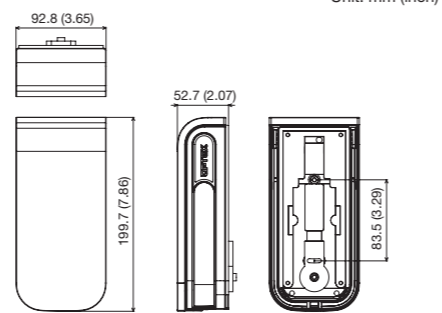

BXS-R / BXS-RAM

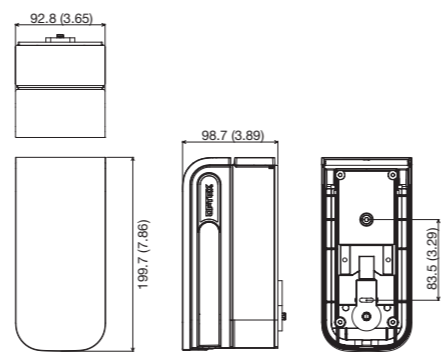

Options

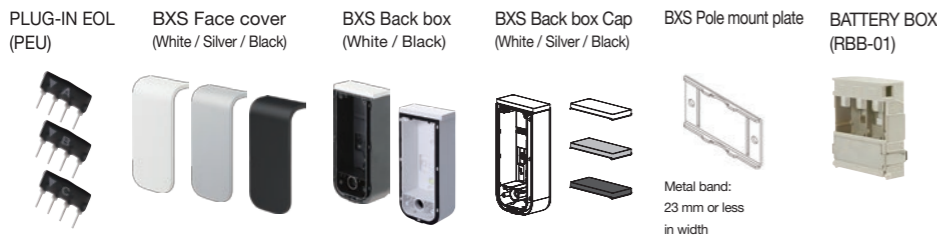

Specifications

Model	BXS-ST	BXS-AM	BXS-R	BXS-RAM
Detection method	Passive infrared		Passive infrared	
Coverage	24 m (80') ; 12 m (40') on each side, 4 zones ; 2 zones on each side, 180° narrow		24 m (80') ; 12 m (40') on each side, 4 zones ; 2 zones on each side, 180° narrow	
PIR distance limit	list the possible range 2.5, 3.5, 6, 8.5, 12 m		2.5 to 12 m (5 levels)	
Detection angle from wall	TO WALL : 0° angled forward AWAY WALL : 3° angled forward selectable		TO WALL : 0° angled forward AWAY WALL : 3° angled forward selectable	
Detectable speed	0.3 to 2.0 m/s (1' to 6'7"/s)		0.3 to 2.0 m/s (1' to 6'7"/s)	
Sensitivity	Normal ; 2.0°C (3.6°F) at 0.6 m/s Extreme high : 1.0°C (1.8°F) at 0.6 m/s selectable for each side individually		Normal ; 2.0°C (3.6°F) at 0.6 m/s Extreme high : 1.0°C (1.8°F) at 0.6 m/s selectable for each side individually	
Power input	9.5 to 18 V DC		3 to 9 V DC Lithium or Alkaline batteries	
Current draw (except walk test)	31 mA max. at 12 V DC	34 mA max. at 12 V DC	15 µA stand-by / 8 mA max. at 3 V DC	16 µA stand-by / 8 mA max. at 3 V DC
Alarm period	2.0 ±1 sec.		2.0 ±1 sec.	
Warm-up period	60 sec. or less (LED blinks)		60 sec. or less (LED blinks)	
Alarm output (R)	28 V DC 0.1 A max. [Individual; Right or General], [N.O. or N.C.] are selectable		Solidstate switch, 10 V DC 0.01 A max. [Individual; Right or General], [N.O. or N.C.] are selectable	
Alarm output (L)	28 VDC 0.1 A max. [Individual; Left or General], [N.O. or N.C.] are selectable		Solidstate switch, 10 V DC 0.01 A max. [Individual; Left or General], [N.O. or N.C.] are selectable	
Trouble output	- N.C. 28 V DC 0.1 A max.		Solidstate switch, 10 V DC 0.01 A max. [N.O. or N.C.] is selectable	
Tamper output	N.C. 28 V DC 0.1 A max. open when face cover, main unit or base unit is removed		Tamper output is shared with trouble output.	
LED indicator	Red LED ; 1. Warm-up 2. Alarm (DIP switch ON or Walk test)	Red LED ; 1. Warm-up 2. Alarm , 3. Masking detection (DIP switch ON or Walk test)	Red LED ; 1. Warm-up 2. Alarm (DIP switch ON or Walk test)	Red LED ; 1. Warm-up 2. Alarm , 3. Masking detection (DIP switch ON or Walk test)
Operation temperature	-30°C to + 60°C (-22°F to +140°F)		-30°C to + 60°C (-22°F to +140°F)	
Environment humidity	95% max.		95% max.	
International protection	IP 55		IP 55	
Mounting	Wall, pole (outdoor, indoor)		Wall, pole (outdoor, indoor)	
Mounting height	0.8 to 1.2 m (2'7" to 4')		0.8 to 1.2 m (2'7" to 4')	
Weight	430 g (15.2 oz.)		550 g (19.4 oz.)	
Accessories	Screw (4 x 20 mm) x 2		[1] Connector for POWER and ALARM (R), [2] Connector for ALARM (L), [3] Connector for TROUBLE, [4] Velcro tape, [5] Screw (4x20 mm) x 2	

• Specifications and designs are subject to change without prior notice.
• These units are designed to detect an intruder and activate an alarm control panel.
• Being only a part of a complete system, we cannot accept responsibility for any damages or other consequences resulting from an intrusion.



BOUNDARY OUTDOOR DETECTOR BX SHIELD series

Where flexible performance meets
modern design

The BX SHIELD is a series of either side
detectors providing 12 m side by side
(total 24 m / 80 ft) coverage:

Black and white models

BXS-ST: 12 m / 40 ft side by side (total 24 m / 80 ft)
BXS-AM: with anti-masking
BXS-R: Battery operated 12 m / 40 ft side by side (total 24 m / 80 ft)
BXS-RAM: with anti-masking

White models

BXS-ST (W)
BXS-AM (W)
BXS-R (W)
BXS-RAM (W)



OPTEX CO.,LTD. (JAPAN)

www.optex.net

OPTEX INC. / AMERICAS HQ (U.S.)
www.optexamerica.com

OPTEX DO BRASIL LTDA. (Brazil)
www.optex.net/br/es/sec

OPTEX (EUROPE) LTD. / EMEA HQ (U.K.)
www.optex-europe.com

OPTEX TECHNOLOGIES B.V. (The Netherlands)
www.optex.eu

OPTEX SECURITY SAS (France)
www.optex-security.com

OPTEX SECURITY Sp.z o.o. (Poland)
www.optex.com.pl

OPTEX PINNACLE INDIA, PVT., LTD. (India)
www.optex.net/in/en/sec

OPTEX KOREA CO.,LTD. (Korea)
www.optexkorea.com

OPTEX (DONGGUAN) CO.,LTD.
SHANGHAI OFFICE (China)
www.optexchina.com

OPTEX (Thailand) CO., LTD. (Thailand)
www.optex.co.th

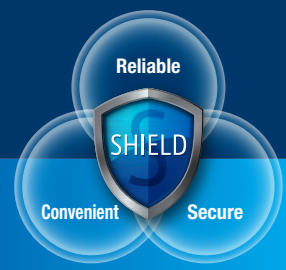

SHIELD: the new shape of security

4 PIR SENSORS, IR DIGITAL ANTI-MASKING AND SHIELD CONCEPT DESIGN

Reliable

12 m / 40 ft. each side long and narrow high sensitivity detection area

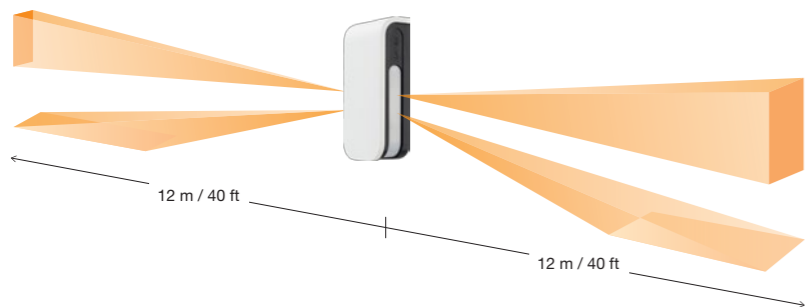

AND logic function to reduce false alarms

The BX SHIELD only triggers an alarm signal when both upper and lower detection areas detect movement.

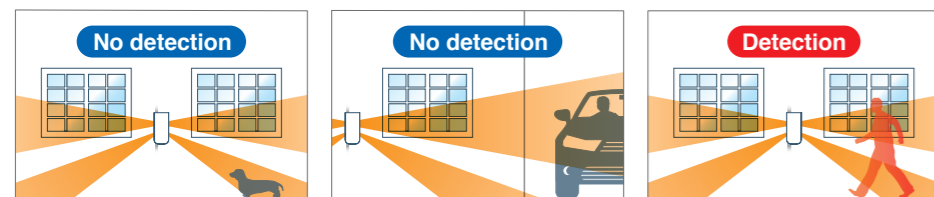

Individual detection area and sensitivity setting

Left and right detection ranges can be independently adjusted. (2.5 to 12 m in 5 steps)

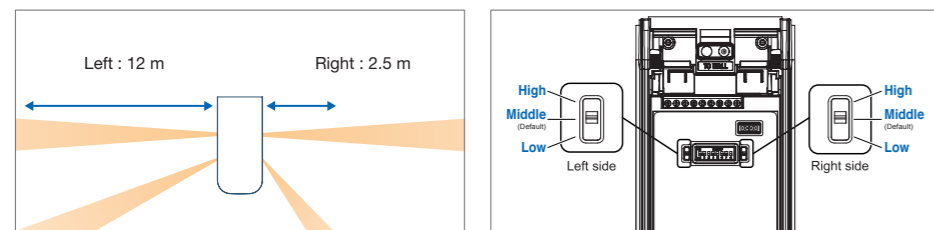

Extreme high detection mode

For environments where the temperature difference between the human body and the background is very small, the extreme high detection mode increases the PIR sensitivity to avoid any missed alarm.



Normal			Extreme		
Normal Low	Normal Mid	Normal High	Extreme Low	Extreme Mid	Extreme High

SMDA (Super Multidimensional Analysis) logic

All BX SHIELD models feature a digitally enhanced signal recognition logic called SMDA. By analyzing the detection patterns and environmental information SMDA can differentiate between a number of noise factors such as changes in weather conditions and vegetation sways; and genuine intrusions. This intelligent processing makes the sensors very reliable.



4 PIR technology

The detection range, sensitivity, alarm output can be set separately for the left and right detection areas. The sensor can differentiate between large and small objects within the detection area, reducing false activations and ensuring genuine intruder detection.

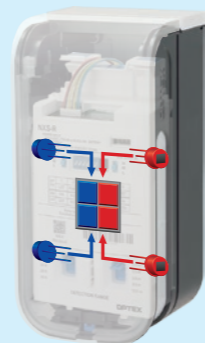

IR digital anti-masking function

Active IR anti-masking detects when the lens surface has been covered, blocked or painted.

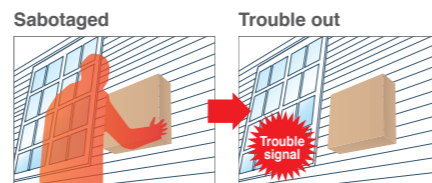

Individual signal outputs (Right and Left)

The BX SHIELD triggers independent alarm signals for the left and the right detection areas which is useful when connected to PTZ cameras.



Convenient

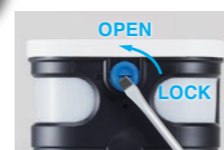

90 degrees rotation open
Easy to open / close cover



Level indicator
The BX SHIELD series features a level indicator to ease the installation process.

Blue Touch™

All accessible parts are colored in blue, making an installation a more friendly procedure.



All the components needed for the sensor's adjustment and settings are in blue.



Easy to adjust the detection area

Automatic walk test mode

Walk test mode will time out after three minutes and the setting will return to "normal mode".

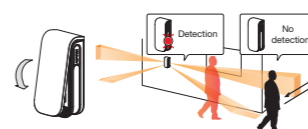

Secure

A sense of security, designed for you



Flat profile supported by an internal honeycomb structure ensures durability.



Optional color variations for a face cover can make installations less obvious.



Optical lens units are sealed and re-enforced to add extra strength.

Back tamper

Trouble output activates when face cover, chassis as well as back box is removed.



Product Features

Battery life for the battery-operated models

Model	BXS-R		BXS-RAM	
	Interval (sec.)	Approx. years	Interval (sec.)	Approx. years
	120	5	120	5
	5	3.5	5	3.5
	3	2	3	2
	4	2.5	4	2.5

Calculations based on ;
Single type battery, no power sharing with transmitter, LED OFF and Anti-masking ON.

Wireless transmitter and battery

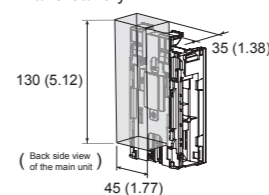

Battery box RBB-01 (option)

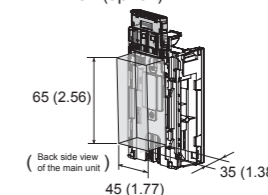

Battery box (RBB-01)

*Battery not included.
CR123A x 3 (3.0 V DC)
CR2 x 3 (3.0 V DC)
1/2AA x 3 (3.6 V DC)
1/2AA x 6 (7.2 V DC x 3)*
*3.6 V DC 1/2 AA battery in series.

EOL module socket (BXS-ST,AM only)

Optional EOL (End of line) resistor modules are available.

SHIELD housing

IP55 protection
UV resistant ASA body

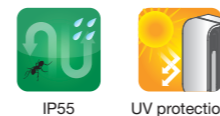

Pole mount plate (option)

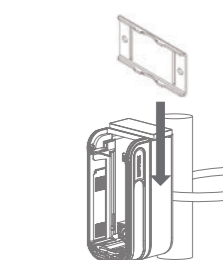

Suitable for a metal band up to 23 mm (1 inch) in width

Versatile design



Black cover / black body



White cover / black body



Silver cover / black body



White cover / white body

Web based manual for wired models
<http://navi.optex.net/manual/50155>



Web based manual for battery operated models
<http://navi.optex.net/manual/50157>



Basic common features

- Double conductive shielding
- Sensitivity adjustment switch
- Cover tamper